

Data Sheet

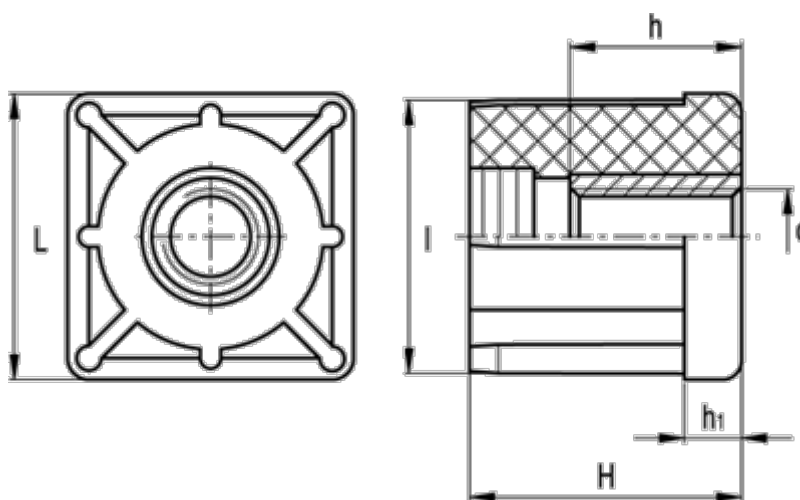

Article number: 2310320082
Description: E+G Square end-cap
NDX.Q-40x1.5-M10

Measures



d	= M10	Tube wall thickness = 1.5
h	= 10	Weight (g) = 47
H	= 38	
h1	= 8	
Internal tube size	= 37.0	
l	= 37.0	
L	= 40	
Outer tube size	= 40	